

Easy Sleep

KOPFTEIL

899115

C95xx/4-x

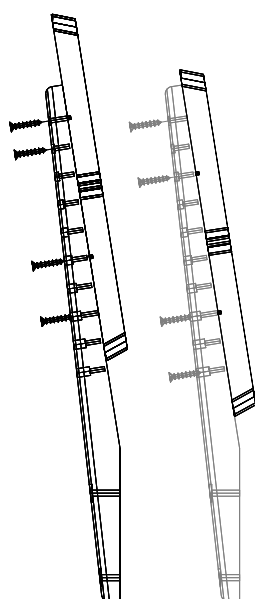
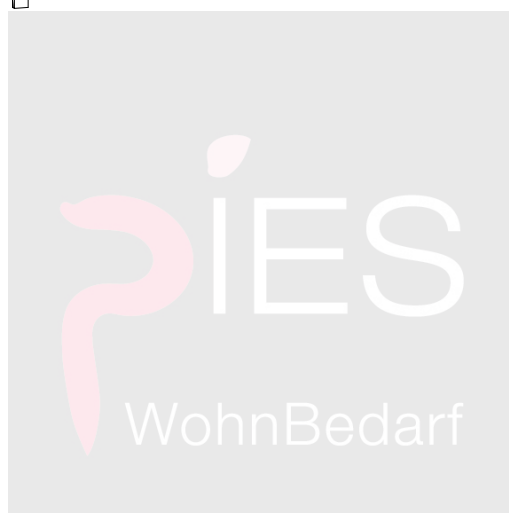
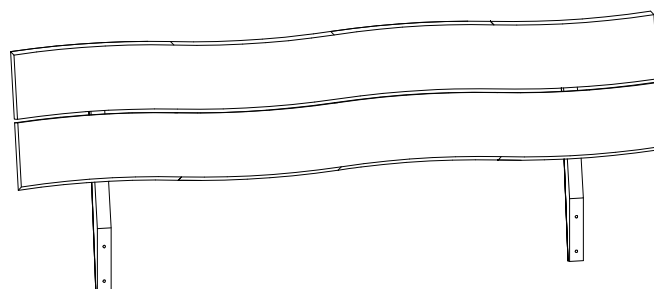





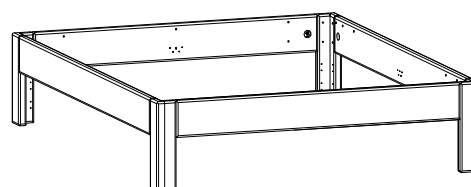
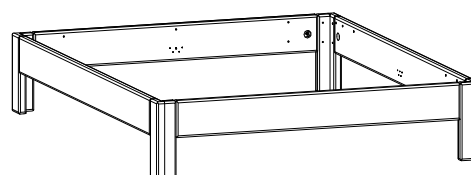

Alt.

C95



2019.05.02

1

- A  = 1
881065
- B  = 2
826065
- C  = 2
826055
- D  = 4
826555
- E  = 4
826571
- F  = 8
853540

738117

H

= 2

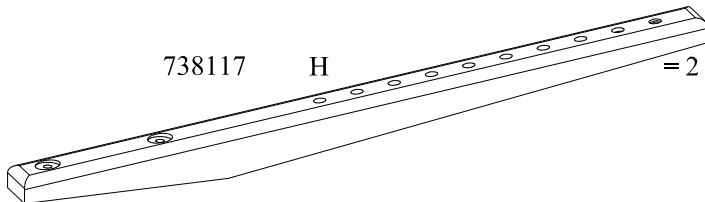

881113

= 1

I



826567

= 4

2

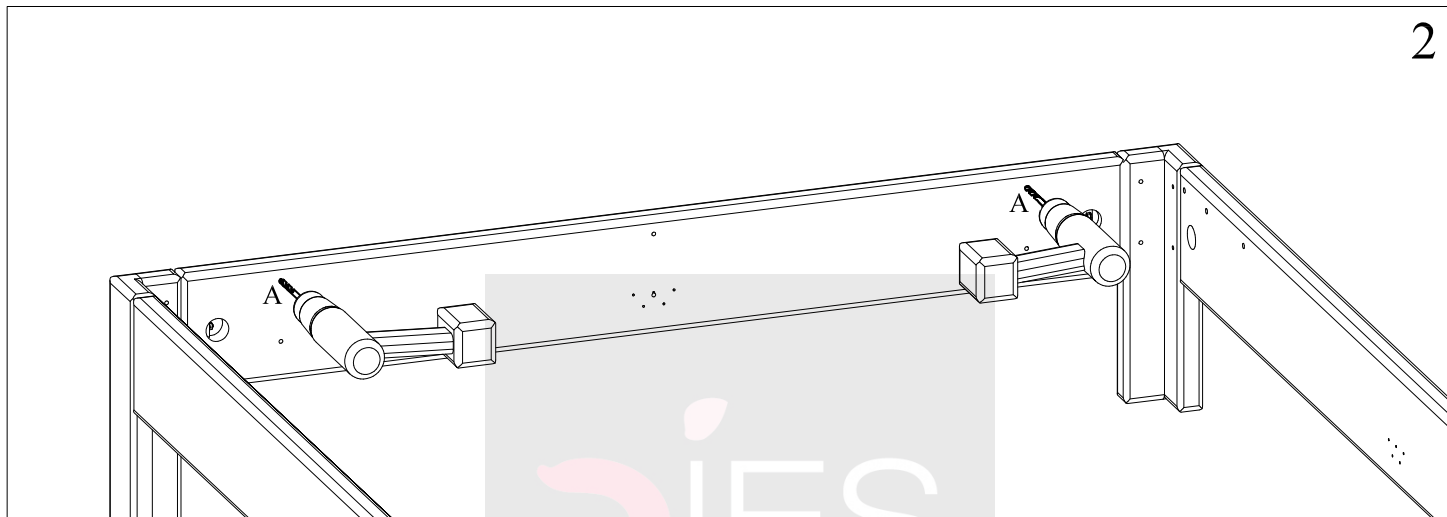

3

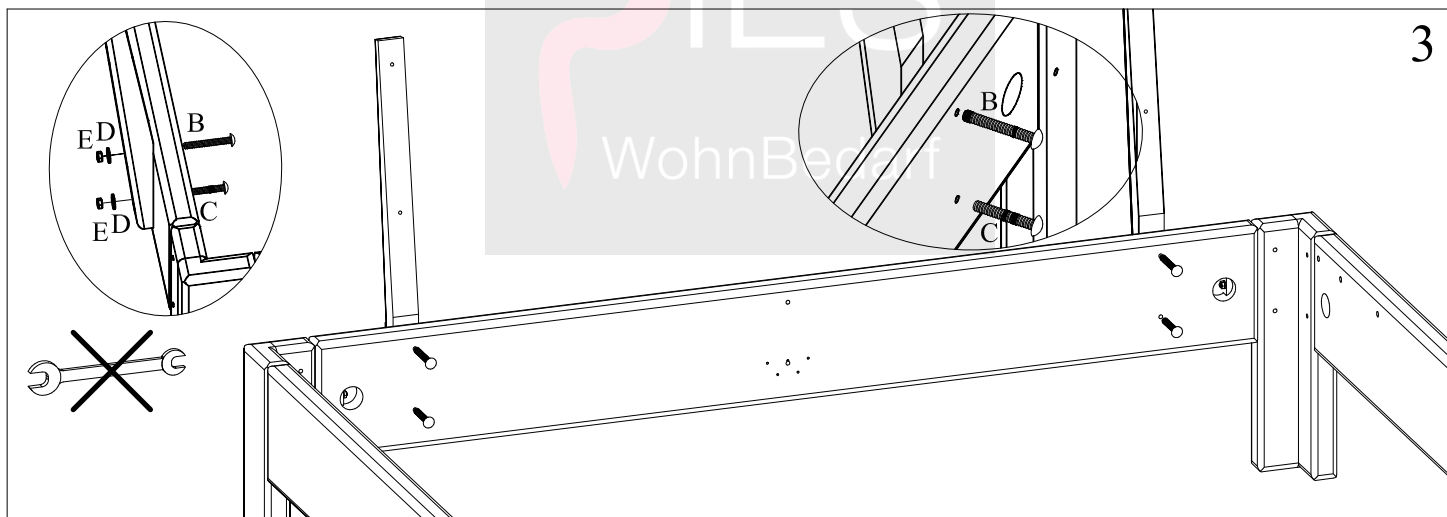

4

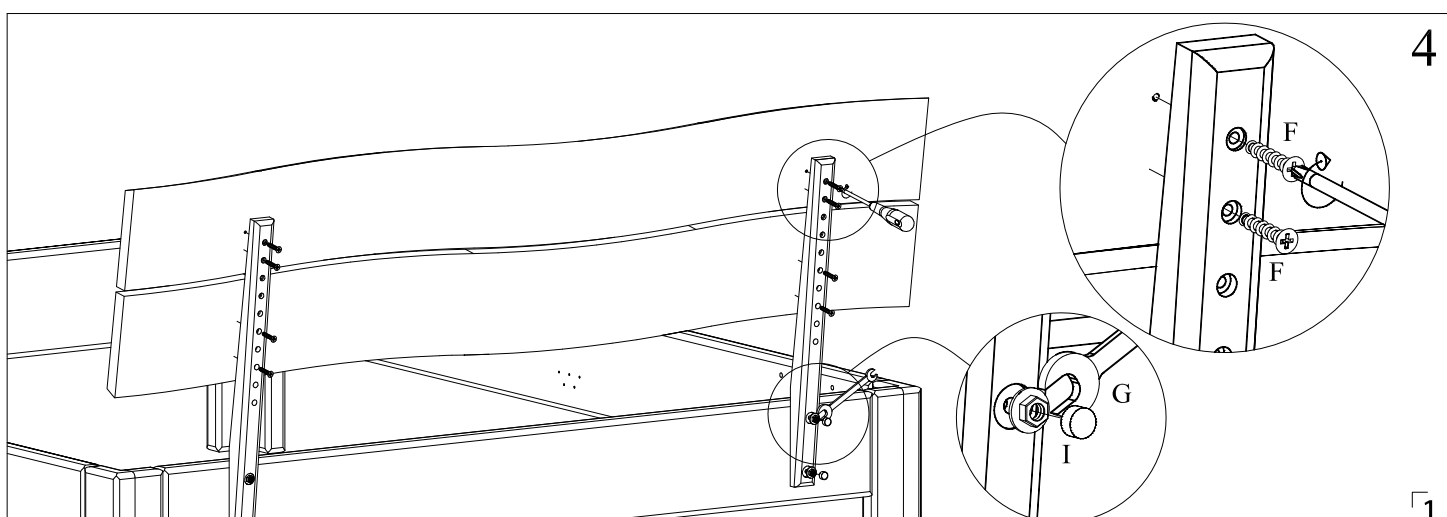

1