

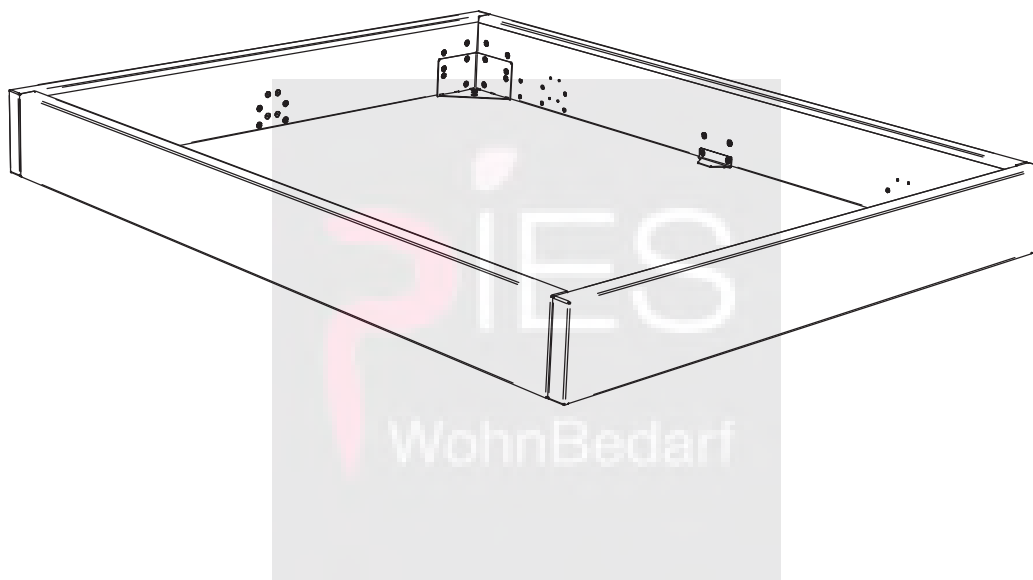

MONTAGEANLEITUNG  
NOTICE DE MONTAGE  
ASSEMBLY INSTRUCTION  
ISTRUZIONE DI MONTAGGIO



1



Zur Montage des Hasena-Bettes sind die Beschläge im Rahmen- und Fusspaket.

Beginnen Sie mit der Montageanleitung ①

Pour l'assemblage du lit Hasena, utiliser la visserie dans le colis du cadre et celui des pieds.

Commencez avec la notice de montage ①



To assemble the Hasena bed the fittings are in the frame- and feet package.

Start with the assembly instruction ①

Per il montaggio dei letti Hasena troverete la ferramenta nel telaio e nel pacchetto piedi.

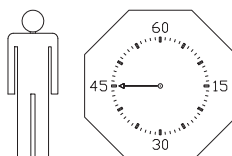
Cominciare con l'istruzione di montaggio ①

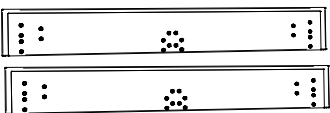
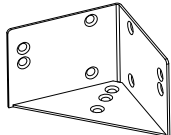

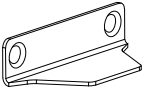
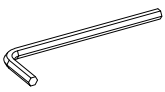
<p>A x2</p> 	<p>B x2</p> 	<p>C x4</p>  <p>630.101</p>	<p>D x28</p>  <p>631.872</p>
<p>E x2</p>  <p>630.099</p>	<p>Z x1</p>  <p>631.100</p>		

1. Einlegetiefe  
Insertion depth  
Profondeur encastrable  
Profondita di inserimento

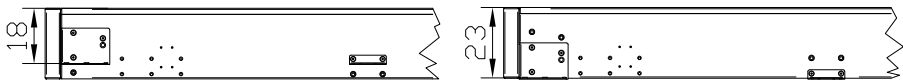
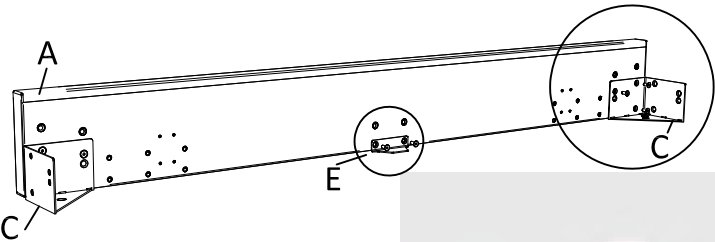
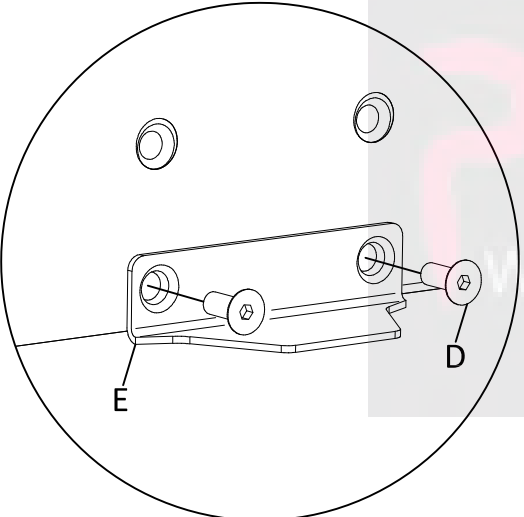
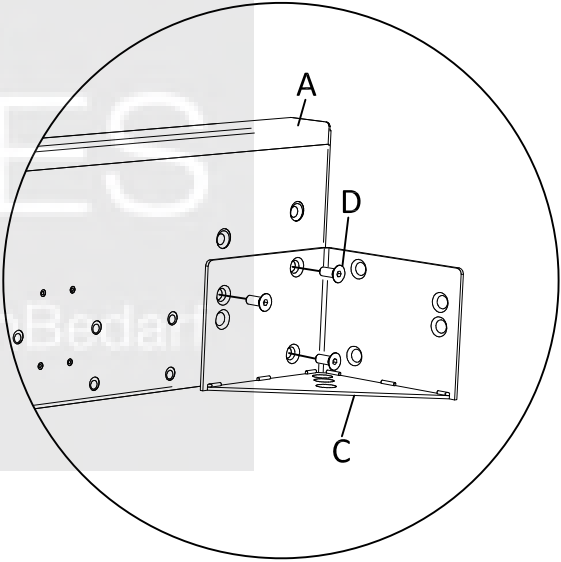
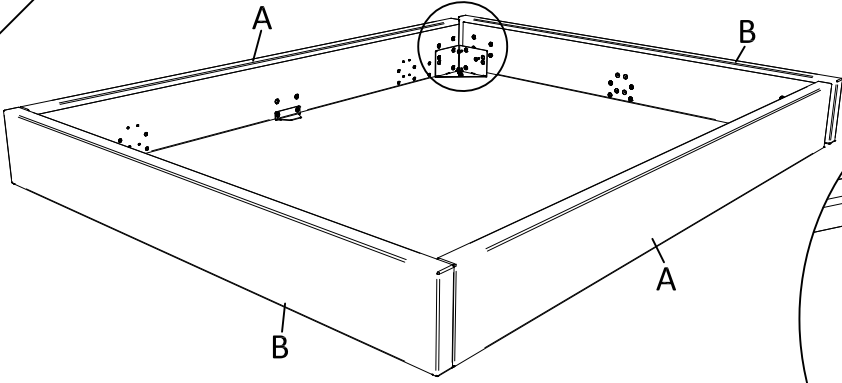
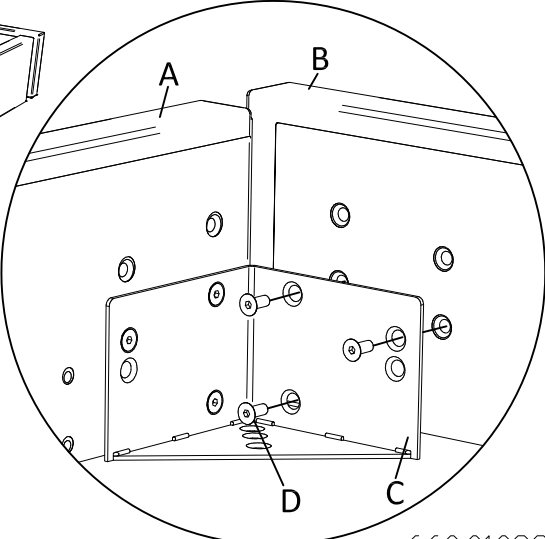
2.

Fussmontage, siehe Montageanleitung ②  
 Foot assembling, see assembly instruction ②  
 Montage des pieds, voir notice de montage ②  
 Fissaggio piedi, vedasi istruzioni di montaggio ②