

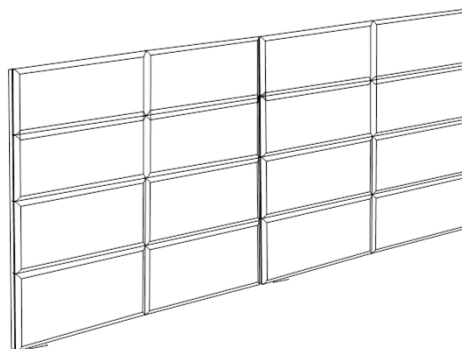

MONTAGEANLEITUNG
NOTICE DE MONTAGE
ASSEMBLY INSTRUCTION
ISTRUZIONE DI MONTAGGIO



Variante A



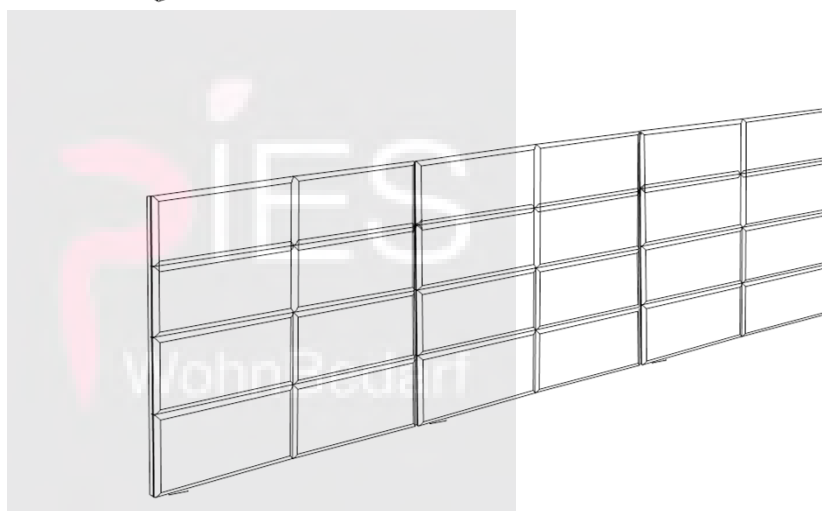

Variante B

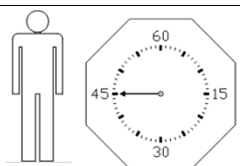
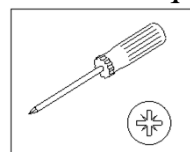
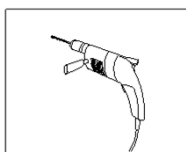

Benötigte Werkzeuge – Outils Nécessaires – Tools Required – Attrezzi Necessari

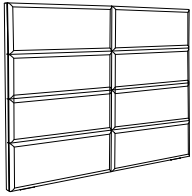
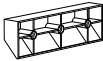
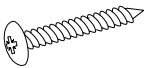

Variante A

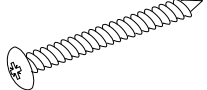
A x2 	B x11  720.00512	D x16 L: 40mm.  631.34700	F x3  630.04000	G x3 L: 60mm.  631.34800
---	---	---	--	--

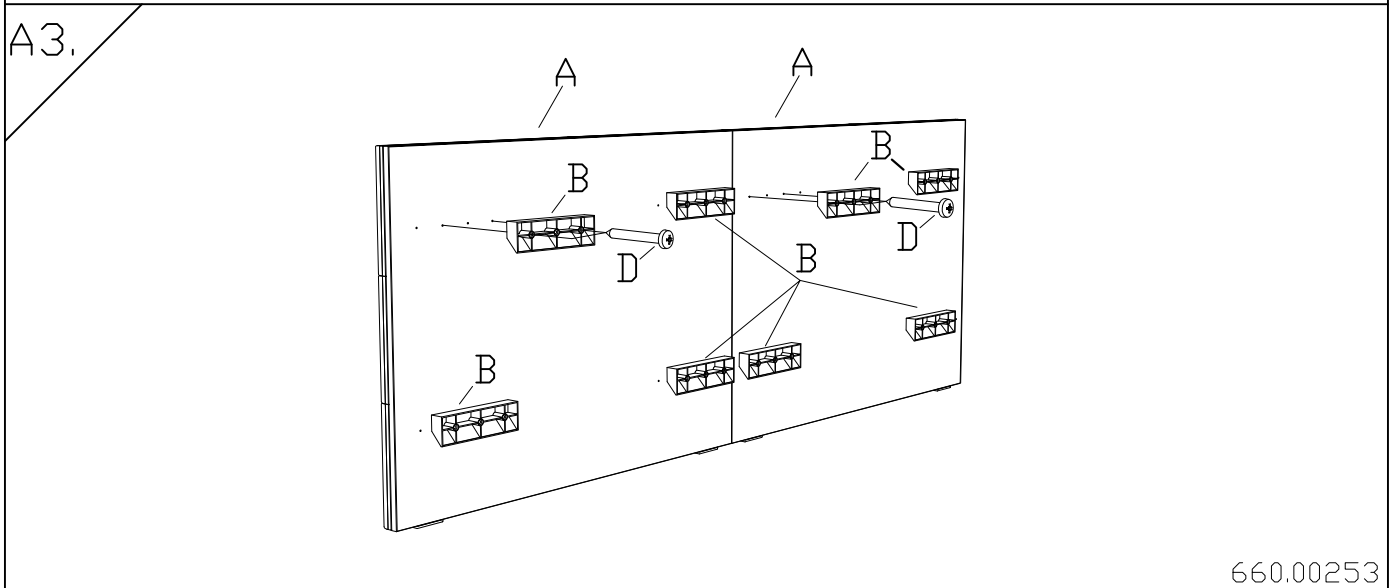
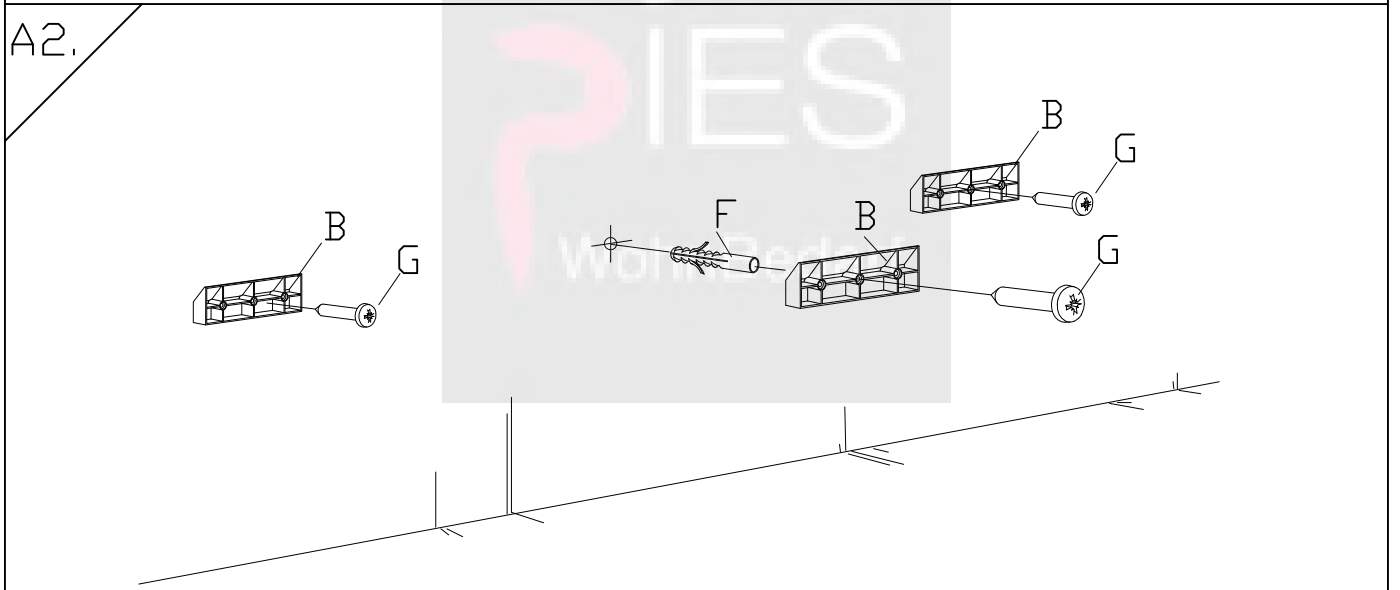
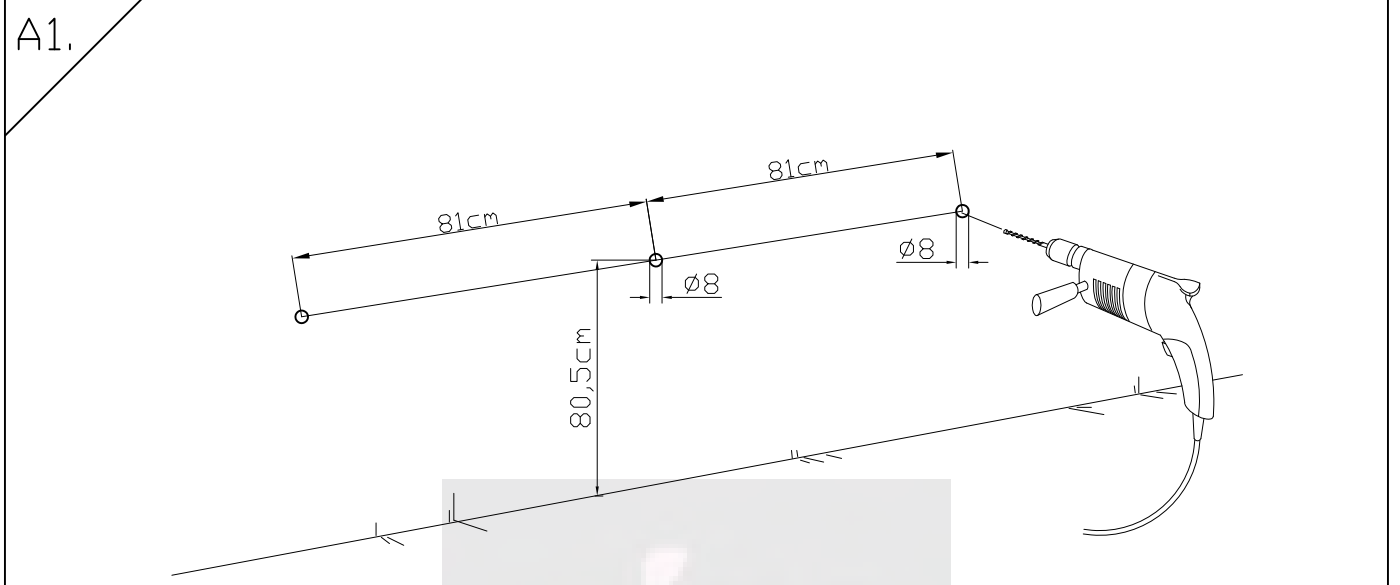

660.00253

A4.

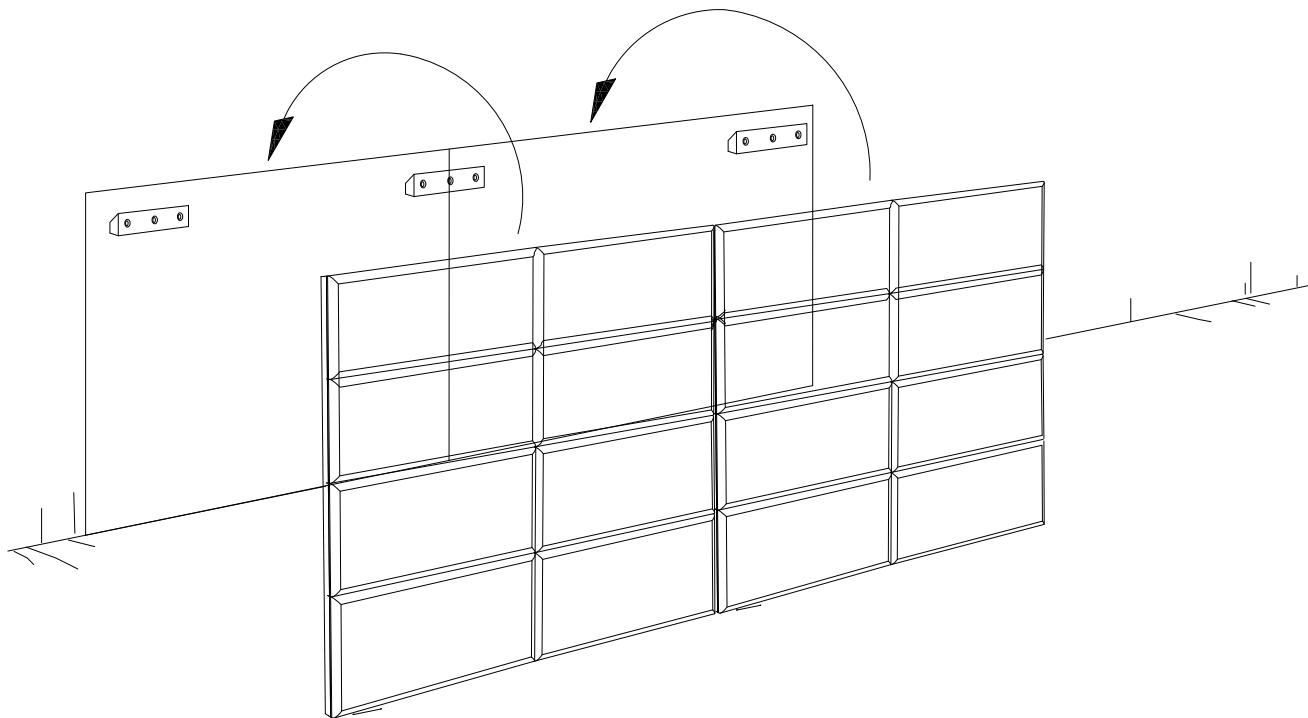

Variante B

A x3

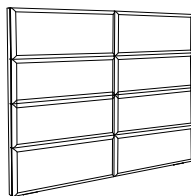

B x16

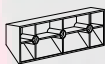

720.00512

D x24

L: 40mm.



631.34700

F x4



630.04000

G x4

L: 60mm.

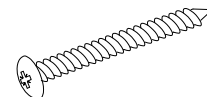

631.34800

B1.

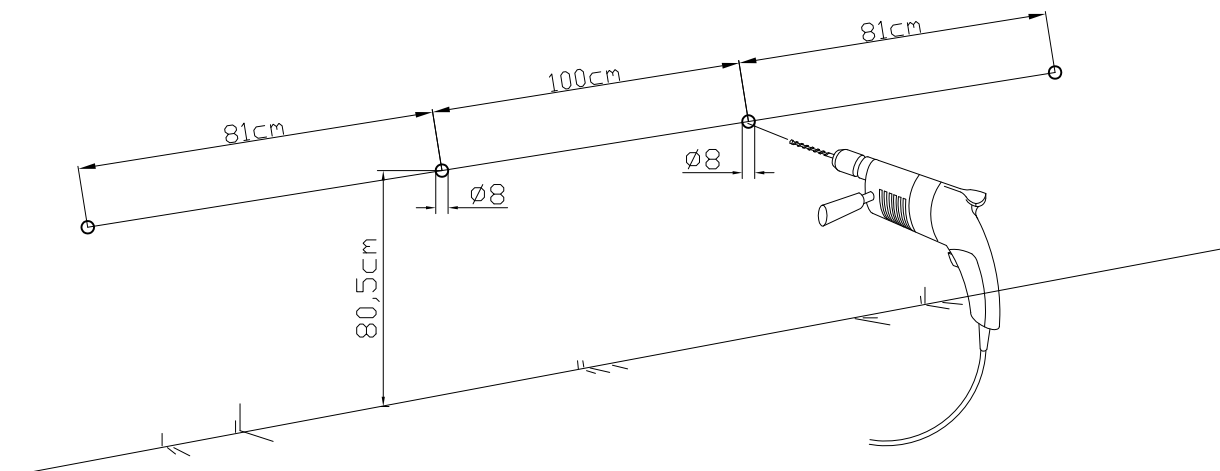

660.00253

B2.

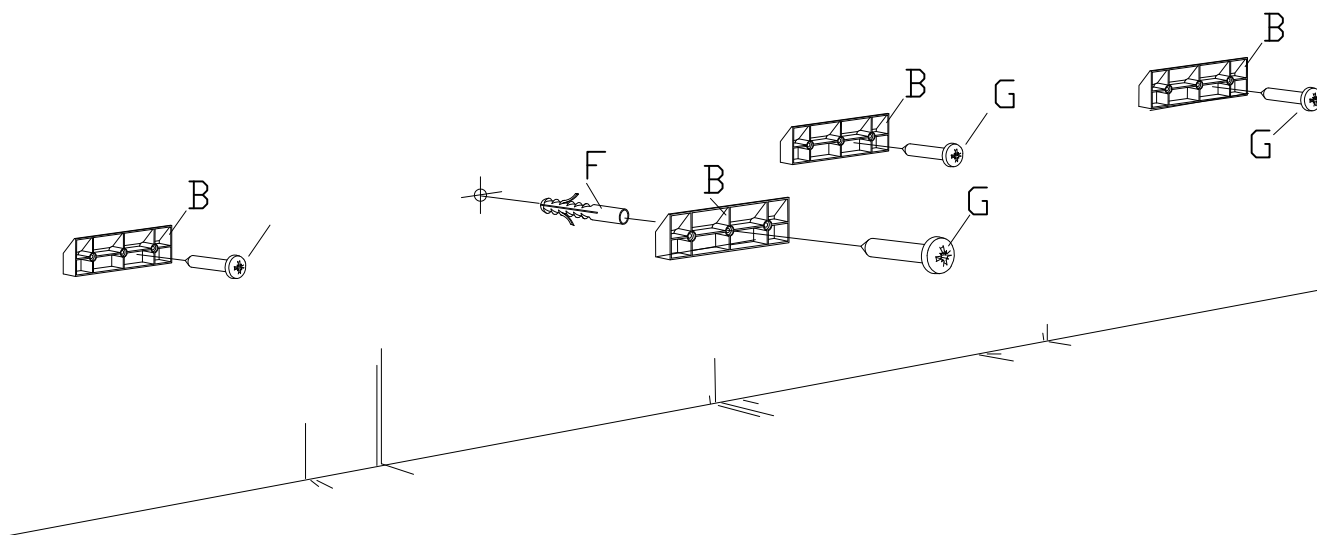

B3.

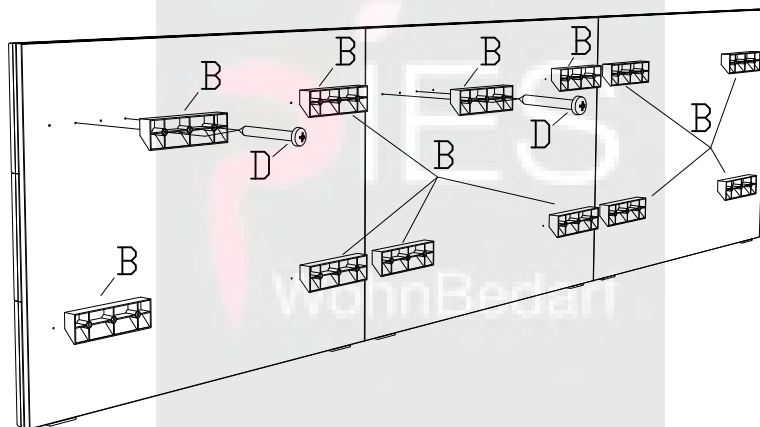

B4.

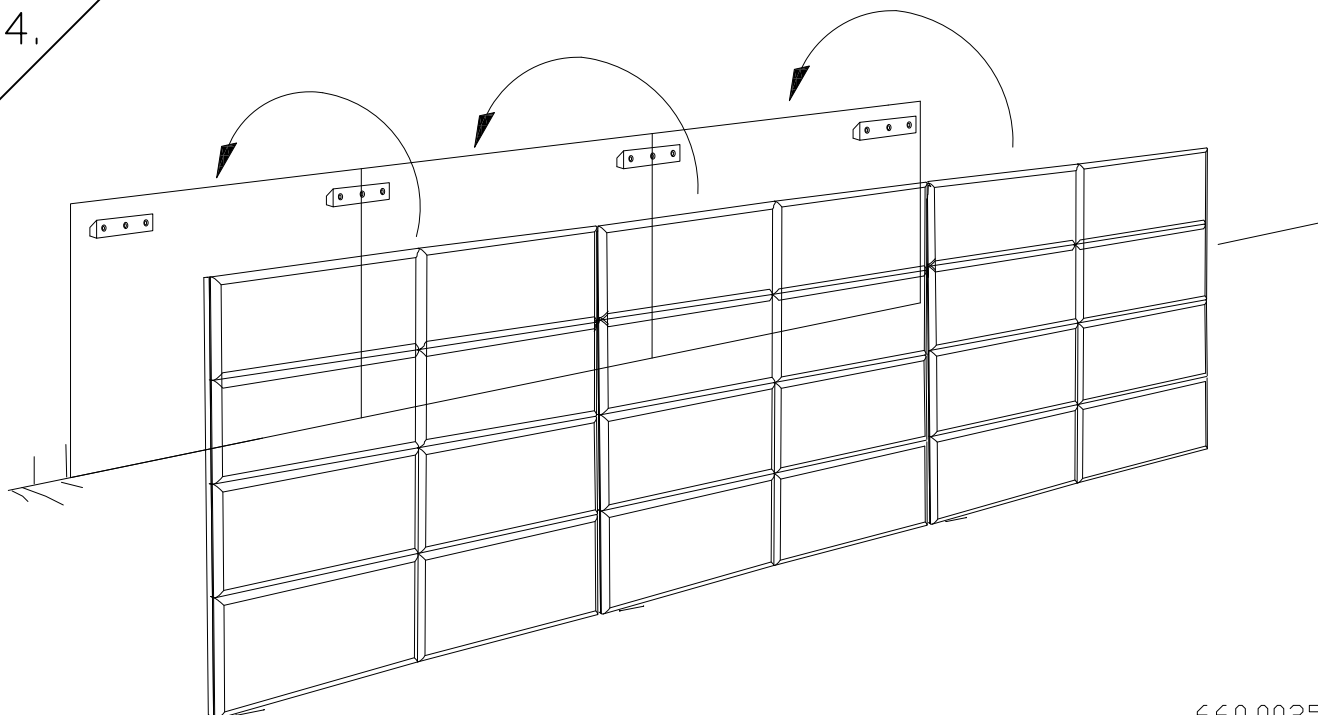

660.00253